

# Hydra T Technical Information

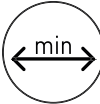

150 cm



150 cm

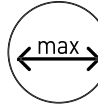

1200 cm



500 cm



General technical plan (mm)

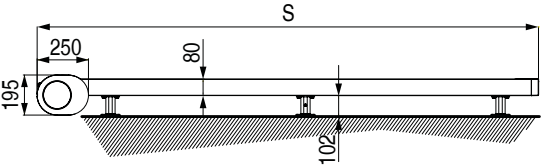

Hood section (mm)

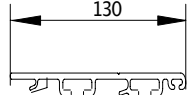

Module 1 (mm)

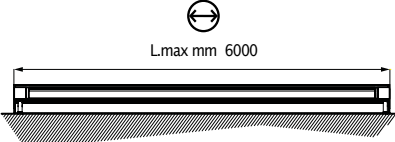

Module 2 (mm)

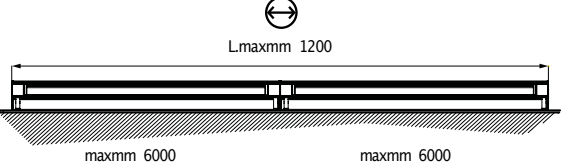

Guides inter axis width

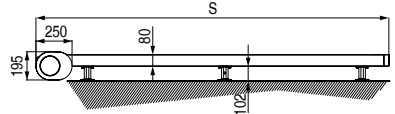
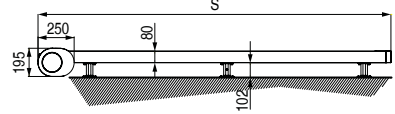
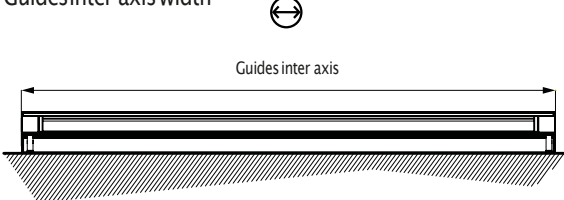

Profiles dimensions (mm)

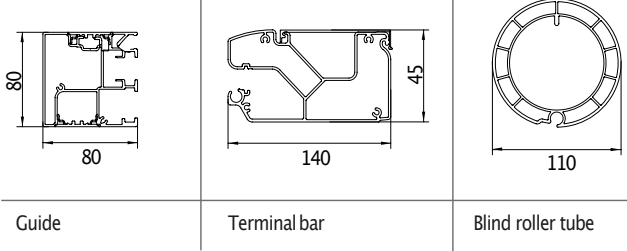

Wall fixing (mm)

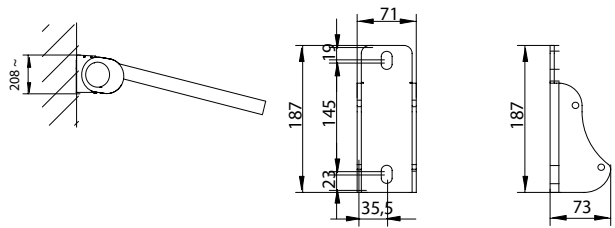

Ground connections (mm)

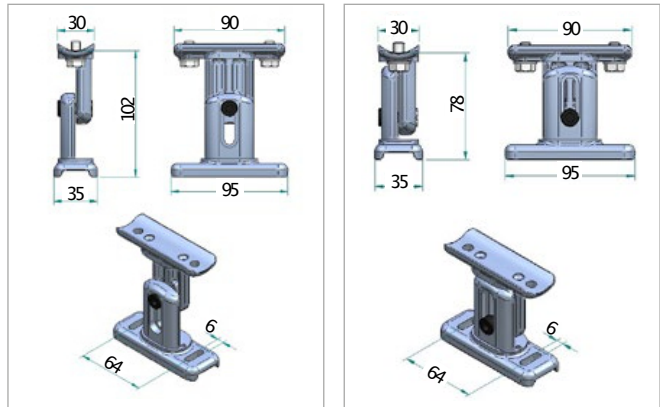

Wall fixing (mm)

